

CYLINDRIX III MINI

VERTICAL TRACK ACCENT LED

APPLICATION

Accent and display lighting for retail, supermarket, commercial & hospitality environments

CONSTRUCTION:

Complete die-cast construction
No exposed wiring
Powder coat paint

ELECTRICAL:

Electronic constant current LED driver, 120v - 277v input
ELV and Triac dimming standard, 120v & 277v.
See following pages for more information.

This product complies with IEEE C62.41 for surge endurance up to 2.5KV. Amerlux® recommends using additional surge protection with this unit (supplied by others), surge damage is not covered by warranty.

OPTICS:

0-180° tilt, 360° rotation
Available in a variety of beam spreads
LED:
Color Temp Options: 2200K, 2700K, 3000K, 3500K, 4000K
CRI: 83 typ. (2700K, 3000K, 3500K, 4000K)
97 typ. (2200K, 2700K, 3000K)
Crisp White LED available
R9 Values: 11 (83CRI), 92 (97CRI)
Binning: 3 MacAdam
Lumen Maintenance: >70% of initial lumens @ 50,000 hrs
Lumen Output (3000K): 1850 lm (89.6 lpw)
CBCP (3000K): SP 13,578

MOUNTING:

Track, canopy, c-clamp and busway
Note: Ceiling mount only

LABELING:



C3MV
LED



PROJECT:

TYPE:



Electrostatic sensitive device,
observe precautions for
handling

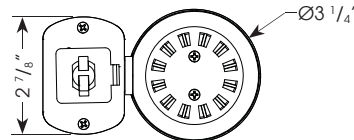
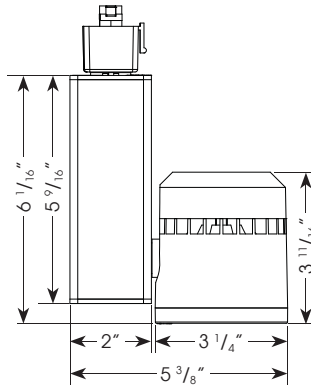
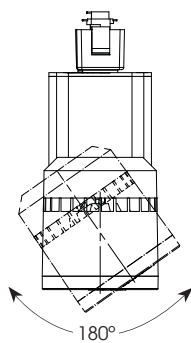

ELECTRICAL

Electronic driver

	21w	
	System Watts	Amps
120v	21	0.18
277v	21	0.08

5 year limited
warranty
AMERLUX LED

(see website for details)

ORDERING INFORMATION:

Model	Wattage	Lamp Type	Finish	Mounting	Voltage	Beam Spread	Color Temp	Options/Accessories
C3MV	21	LED	WT - white texture BT - black texture ST - silver texture - - - (other RAL)	TN1 - Global 1cir/H-Style, 120v TEK - Global 2cir/2neut, 120v TN3 - Global 3cir, 120v TN2 - Global 2cir/2neut, 277v CT - J-Style LOL - L-Style CPR - Capri adapter LLAB - Litalab Bus Run, 120v B - busway C - canopy CCL2 - C-clamp with SCP - straight cord, 6' CCP - coil cord, 5'	120 277	SP - spot, 14° VNF - very narrow flood, 18° NF - narrow flood, 23° FL - flood, 34° WF - wide flood, 44°	83 CRI 2700 3000 3500 4000 97 CRI 2200-97 2700-97 3000-97 CRISP - crisp white	SN - snoot LS - linear spread HEX - hexcel louver CB - cross blade, matte black, requires snoot SOL - solite beam softening lens

Example: C3MV-21-LED-WT-TN1-120-FL-3000

Cat #:

Amerlux reserves the right to change details that do not affect overall function and performance.

CYLINDRIX III MINI

VERTICAL TRACK ACCENT LED

C3MV
LED



TYPE:



FIXTURE DATA:

Complete photometric data (ies format) available upon request.
CCT Correction Factors: 2700-83 = 0.92; 3500-83 = 1.08; 4000-83 = 1.17; 2700-97 = 0.77; 3000-97 = 0.84; Crisp = 0.78

21W LED (3000K)

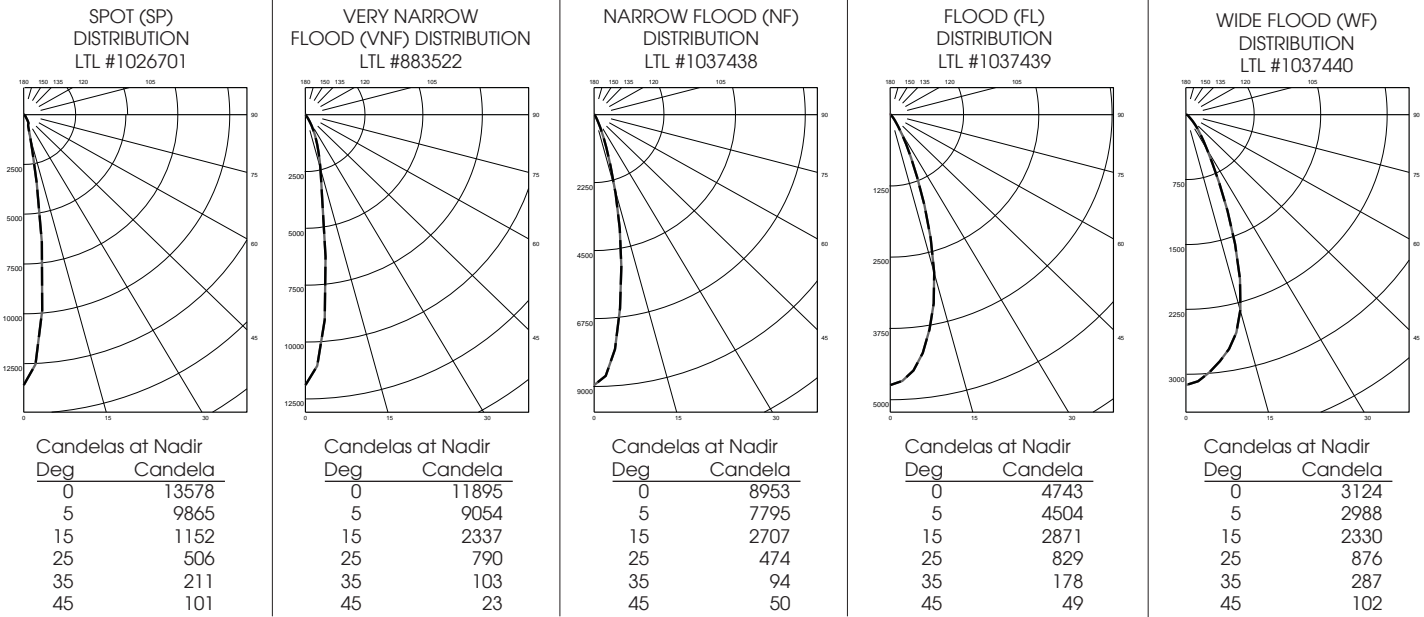

APPLICATION DATA:

Notes and Definitions:

Beam spread is to 50% center beam candlepower (CBCP).
D=Distance to floor or wall.
FC=Footcandles on floor or wall at center beam aiming location.
L=Effective Visual Beam length in feet (50% of maximum footcandle level).
W=Effective Visual Beam width in feet (50% of maximum footcandle level).
CB=Distance across or down to center beam location.

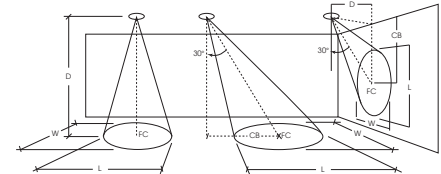

	0° Aiming Angle Horizontal Footcandles				30° Aiming Angle Horizontal Footcandles					30° Aiming Angle Vertical Footcandles					60° Aiming Angle Vertical Footcandles				
	D	FC	L	W	D	FC	L	W	CB	D	FC	L	W	CB	D	FC	L	W	CB
SPOT	5.0'	540	1.2	1.2	5.0'	348	1.6	1.4	3.0	3.0'	200	2.8	1.4	5.0	3.0'	726	1.3	1.1	2.0
	7.5'	241	1.8	1.8	7.5'	155	2.5	2.2	4.0	4.0'	121	3.5	1.8	6.0	4.0'	518	1.5	1.2	2.0
	10.0'	136	2.6	2.6	10.0'	85	3.4	3.0	6.0	5.0'	77	4.3	2.5	8.0	5.0'	334	1.8	1.3	3.0
	12.5'	87	3.2	3.2	12.5'	57	4.2	3.6	7.0	6.0'	54	5.2	2.9	9.0	6.0'	230	2.2	1.6	3.0
VERY NARROW FLOOD	5.0'	473	1.4	1.4	5.0'	305	1.9	1.5	3.0	3.0'	176	3.4	1.5	5.0	3.0'	651	1.6	1.2	2.0
	7.5'	211	2.1	2.1	7.5'	136	2.9	2.5	4.0	4.0'	108	4.1	2.0	6.0	4.0'	462	1.6	1.3	2.0
	10.0'	119	2.9	2.9	10.0'	75	3.8	3.3	6.0	5.0'	67	5.3	2.8	8.0	5.0'	293	2.0	1.5	3.0
	12.5'	76	3.5	3.5	12.5'	50	4.7	3.9	7.0	6.0'	49	6.3	3.2	9.0	6.0'	206	2.4	1.8	3.0
NARROW FLOOD	5.0'	358	1.9	1.9	5.0'	257	2.4	2.1	3.0	3.0'	181	3.2	1.8	4.0	3.0'	620	1.9	1.2	2.0
	7.5'	159	2.9	2.9	7.5'	115	3.5	3.2	4.0	4.0'	96	4.4	2.8	6.0	4.0'	426	1.9	1.5	2.0
	10.0'	90	3.8	3.8	10.0'	63	4.8	4.2	5.0	5.0'	63	5.3	3.3	7.0	5.0'	249	2.5	2.2	3.0
	12.5'	58	4.8	4.8	12.5'	40	6.1	5.4	7.0	6.0'	43	6.7	4.0	8.0	6.0'	182	2.9	2.6	3.0
FLOOD	5.0'	190	2.9	2.9	5.0'	130	3.5	3.1	2.0	3.0'	113	3.4	2.7	3.0	3.0'	340	2.3	1.8	1.0
	7.5'	85	4.3	4.3	7.5'	58	5.2	4.8	3.0	4.0'	64	4.6	3.5	4.0	4.0'	208	2.8	2.6	2.0
	10.0'	48	5.7	5.7	10.0'	34	6.8	6.4	5.0	5.0'	41	5.8	4.4	5.0	5.0'	133	3.5	3.1	2.0
	12.5'	31	7.2	7.2	12.5'	22	8.5	8.0	6.0	6.0'	29	7.0	5.2	7.0	6.0'	93	4.1	3.8	3.0
WIDE FLOOD	5.0'	125	3.3	3.3	5.0'	92	3.9	3.5	2.0	3.0'	92	3.2	2.7	3.0	3.0'	254	2.3	2.0	1.0
	7.5'	56	5.0	5.0	7.5'	41	5.6	5.4	3.0	4.0'	52	4.3	3.6	4.0	4.0'	138	3.2	3.0	2.0
	10.0'	32	6.7	6.7	10.0'	23	7.6	7.3	4.0	5.0'	34	5.3	4.6	5.0	5.0'	93	3.9	3.5	2.0
	12.5'	20	8.5	8.5	12.5'	15	9.6	9.2	5.0	6.0'	23	6.5	5.5	6.0	6.0'	64	4.7	4.5	2.0

CYLINDRIX III MINI

VERTICAL TRACK ACCENT LED

C3MV
LED



TYPE:



DIMMING COMPATIBILITY:

Amerlux® fixtures are compatible with all major dimming protocols prevalent in the United States. Please see below for general compatibilities and wiring diagrams. Amerlux recommends testing your unique dimming configuration as the exact full configuration (Dimmer, Fixture Quantity, Voltage, etc) may affect dimming performance.

TRIAC (Forward Phase) DIMMING (standard)

Utilizes "Standard" incandescent dimmers that are in wide use in installations across the US. Best for retrofit applications where Triac dimmers are installed.

Notes:

- 120v & 277v
- Dims down to less than 5% light output (most cases)
- Consult Dimming manufacturer for installation instructions - DO NOT SHARE NEUTRALS!
- Must meet dimmer Minimum Load Requirements per dimming manufacturer

Wiring Diagram

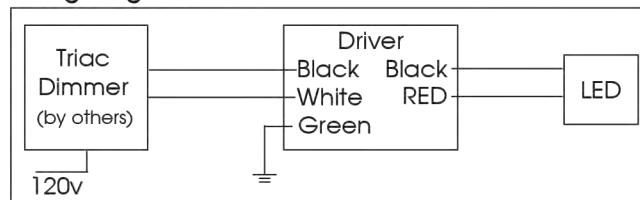

Compatible Dimmers

Wall Box (Incandescent Style, Wattage as required)

Lutron "Diva"
Lutron "Nova-T"
Lutron "Maestro"

Lutron "Vareo"
Lutron "Skylark"

Central System

ETC "SR" Rack w/D20
Module
Lutron "GP" Panel

ETC "DRD" Rack w/D20
Module
Lutron Grafix Eye QS

ELV - Electronic Low Voltage (Reverse Phase) DIMMING (standard)

Utilizes specialized "ELV" dimmers. Best for New Construction applications

Notes:

- 120v & 277v
- Dims down to less than 5% light output (most cases)
- Consult Dimming manufacturer for installation instructions - DO NOT SHARE NEUTRALS!
- Must meet dimmer Minimum Load Requirements

Wiring Diagram

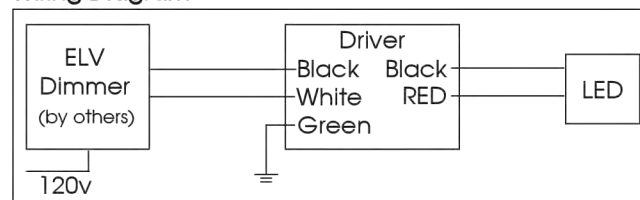

Compatible Dimmers

Wall Box (ELV Style)

Lutron "Diva"
Lutron "Nova-T"
Lutron "Maestro"
Leviton "Surslide"

Lutron "Vareo"
Lutron "Skylark"

Leviton "Vizio"

Central System

ETC "SR" Rack w/ELV10
Module
Lutron "GP" Panel with
PHPM-PA Interface

ETC "DRD" Rack w/ELV10
Module
Lutron Grafix Eye QS with
PHPM-PA Interface

Representante Exclusivo
BHP Energy México S. de R.L de C.V

Bosque de Durazos #69 - Torre B 1107-A, Col.Bosques de las Lomas, México DF. 11700
Tel: +52 55 5251 2008 / info@bhpenery.mx / ventas@bhpenery.mx / www.bhpenery.mx